

PRIOR to USE

Install the mount onto a strong structure such as a concrete, etc.
 Use the supplied accessories when installing the mount to a structure, make sure that all the screw parts are metallic.
 Follow the mounting instructions and refer the application mounting accessories.

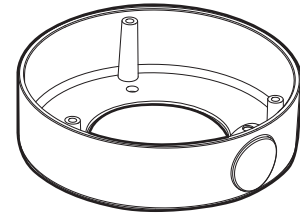

PARTS SUPPLIED

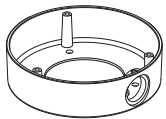

Mount Adaptor

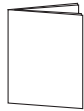

Instruction Guide

Plastic Anchor
6x30mm (Q'ty:4)



Mounting Screw
M4x30mm (Q'ty:4)



Assembly Screw
4x14mm(Q'ty:3)



BM Screw
2.6x6mm(Q'ty: 1)



L-Wrench
3mm(Q'ty:1)



Pipe hole Cap
(Q'ty: 1)



Cable Gland
Q'ty : 1

Gland hole plug
Ø4.5 (Q'ty:1)
Ø2.7 (Q'ty:1)



DIMENSIONS

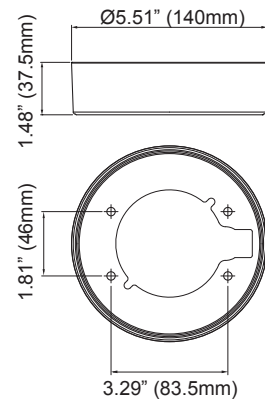

INSTALLATION

1. Locate the mounting template at the installation position and drill the ceiling or wall if needed.
2. Open the dome cover by loosening screws(4x12mm). Use the torque wrench supplied.
3. Place the surface mount on pre-drilled position and fix it through using mounting screws.
 Assemble the cable pipe, otherwise tighten a pipe hole cap.
4. Route the power cable to the connecting place.
5. Affix the dome base unit to the surface mount using the assembly screws(4x14mm).
 Before fixing the dome base, make sure the assembly holes should be aligned with the surface mount assembly holes.
6. Set the camera's viewing angle and adjust zoom&focus.
7. Put the dome cover to the dome base unit and tighten the assembly screws.

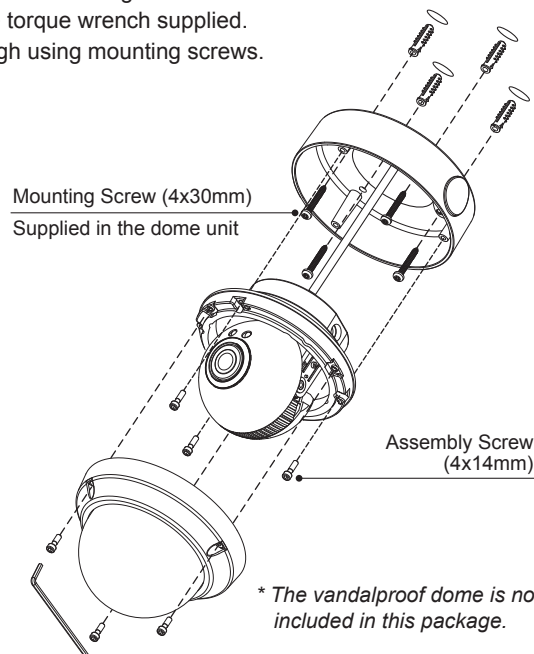

* The vandalproof dome is not included in this package.

APPLICATION

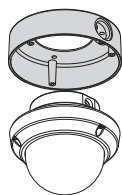

+



Pole mount adapter
(mounting on the pole-like structure)

Wall mount bracket
(mounting on the wall)

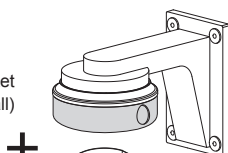

+



SPECIFICATIONS

Construction: Aluminum cast
 Environment: Indoor/Outdoor for Vandalproof dome
 Dimension: 5.51 1.48" (140x37.5)
 Weight: 0.49 lb (220g)