



VTC-C680
VTC-C750
VTC-C680/DN
VTC-C750/DN
1/3" Color Camera Series



- 1/3" Super HAD CCD With 550 TVL (VTC-C750 / VTC-C750DN) & 480 TVL (VTC-C680 / VTC-C680DN)
- Minimum Illumination 0.02 Lux (F1.2) (VTC-C680DN / VTC-C750DN) & 0.2 Lux (F1.2) (VTC-C680 / VTC-C750)
- Accepts DC Servo Type Auto Iris Lenses
- 2000-8000 Degree K Automatic White Balance Tracking
- Max 1/100,000 Sec. Electronic Shutter
- Better Than 48dB S/N Ratio (VTC-C680 / VTC-C750) & 50dB (VTC-C680DN / VTC-C750DN)
- 12VDC / 24VAC Dual Voltage Operation

VITEK



1. Unit contains uninsulated dangerous voltage within the enclosure that may be of sufficient magnitude to constitute a risk of electric shock to persons
2. Only use DC Power Supply
3. Read & Keep these instructions.
4. Heed to all warnings and follow all instructions carefully.
5. Do not use near water.
6. Clean only with dry cloth.
7. Do not block any ventilation openings. install in accordance with the instructions.
8. Do not install near any heat source such as radiators, heat resisters, stoves, or other apparatus (including amplifiers) that produce heat.
9. Do not defeat the safety purpose of the polarized or grounding-type plug. A polarized plug has to blades with one wider the other. A grounding type plug has to blades and a third grounding plug. The wide blade or the third prong are provided for safety. if the provided plug dose not fit into your into your outlet, consult an electrician for replacement of the obsolete outlet.
10. Protect the power cord from being walked on a pinched particularly at plugs, convenience receptacle, and the point where they exit from the apparatus.
11. Only use attachment/accessories specified by VITEK.
12. Use only with cart, stand, tripod, bracket, or table specified by the manufacturer, or sold with the Unit,
13. Unplug this unit during lightning storms or when unused for long periods of time.
14. Refer all servicing to qualified service personnel, Servicing is required when the unit has been damaged in any way, such as power-supply cord or plug is damaged, liquid has been spilled or objects have fallen into the unit, the unit has been exposed to rain or moisture, does not operate normally or has been dropped.
15. Do not attempt to service this product yourself as opening or removing covers may expose you to dangerous voltage or other hazards. Refer all servicing to qualified service personal.

CAUTION - To reduce the risk of electric shock, do not perform any servicing other than contained in these operating instructions unless you are qualified to do so.



CONTENTS

Safety Instructions & Notes	3
Cleaning	3
Introduction / Features	4
Package Contents	5
Camera Layout	5
Rear Camera Layout	6
External Controls	7-9
Power Supply Connections	9
Specifications	10-11
Warranty	12

SAFETY INSTRUCTIONS & NOTES

- Please read these safety and operating instructions before putting the camera into operation.
- Keep the operating instructions in a safe place for later use.
- The Standard Box Camera is designed for indoor use only and it must not be installed where exposed to rain and moisture.
- The unit may only be opened by authorized personnel.
- Do not operate the cameras beyond their specified temperature, humidity or power ratings.
- Pay attention when laying the connection cable and observe that the cable is not subject to heavy loads, kinks, or damage and no moisture can get in.
- Power **MUST** be removed during installation.
- Do not attempt to disassemble the camera board from the camera.
- The warranty becomes void if repairs are undertaken by unauthorized persons.
- Contact the supplier if any functional problems arise.

CLEANING

- Do not use strong or abrasive detergents when cleaning this product.
- Use a dry cloth to clean the camera surface. In case the dirt is hard to remove, use a mild detergent and wipe gently.



INTRODUCTION

VTC-C680 (VTC-C680DN for D&N) and VTC-C750 CCD Color Camera (VTC-C750DN for D&N) are high performance standard box type color cameras that adopt the most advanced 410,000 pixel 1/3" CCD. They are designed to have a conventional camera appearance to act as a crime deterrent as well as remain unobtrusive when installed. Its versatile design supports CS mount lens options allowing for various angles according to the targeted installation environment. Their innovative LPF (Low Pass Filter) and DSP technologies help represent natural colors. They are designed for indoor use or outdoor use when installed in a weatherproof enclosure such as the VITEK VT-EH10.

By utilizing a SONY CCD as well as a SONY HQ1 DSP, this camera provides exceptionally sharp image quality up to 550TV Lines (for VTC-C750 & VTC-C750DN). Through its backlight compensation function, it is able to give brighter and sharper images of an object or objects darkened by background lighting or sunlight. Their highly sensitive Super-HAD CCD also provides an auto white balance function, ensuring accurate representation of colors under any lighting environment.

Either 24VAC or 12VDC (Non-Polarity) may be used with the use of a power adapter.

FEATURES:

- 1/3" Sony DSP Super-HAD Interline Transfer CCD
- Resolution of 480 Horizontal Lines (VTC-C680 / C680DN) / 550 Horizontal Lines (VTC-C750 / C750DN)
- 10x Sensitivity enhancement with automatic optical filter (VTC-C680DN / C750DN)
- Switches to B/W, enabling IR sensitivity in night mode (VTC-C680DN / C750DN)
- Enhanced sharpness compensation
- Very low noise and superior picture quality
- Sensitivity of 0.02Lux (B&W) (VTC-C680DN / C750DN) & 0.2Lux (Color) (VTC-C680 / C750)
- Supports DC (and Video) auto iris lens
- Automatic and Manual Removable IR Cut Filter (VTC-C680DN / C750DN)
- Digital signal processing (DSP)
- Automatic Shutter Control (AES)
- Automatic White Balance (ATW)
- Dual Voltage: 12VDC/24VAC

PACKAGE CONTENTS

- 1 x 1/3" Digital Color Camera
- 1 x Lens Connector Plug (VTC-C680 / C680DN Only)
- 1 x CCD dust protection cap
- 1 x Instruction Manual

CAMERA LAYOUT

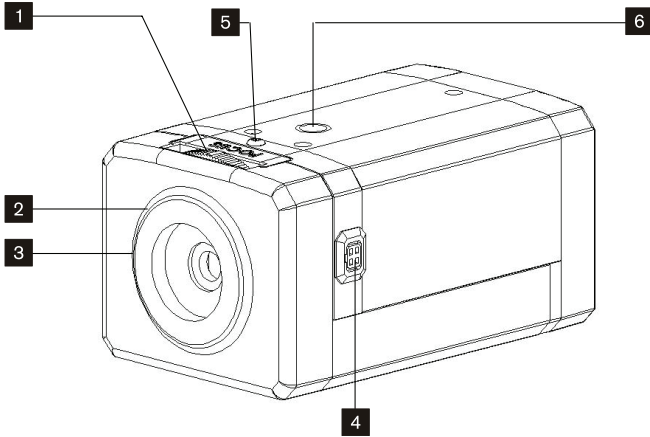

- 1)** Back Focus Adjustment
- 2)** C-Mount Adapter Ring
- 3)** CCD Dust Protection Cap
- 4)** Lens Connector for Auto-Iris Lenses
- 5)** Back Focus Adjustment Screw
- 6)** Threaded Camera Mount

4) Auto-iris lens Lens Connector

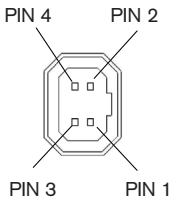

Pin	Video Drive	DC Drive
1	V+(10V out)	Damp(-)
2	No Connect	Damp(+)
3	Iris Signal	Drive(+)
4	GND	GND

REAR CAMERA LAYOUT

VTC-C680

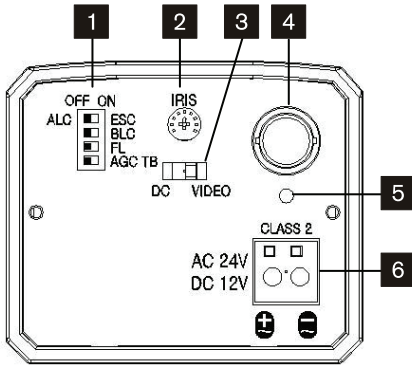

VTC-C680/DN

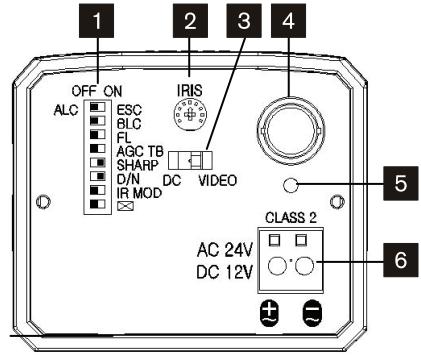

VTC-C750

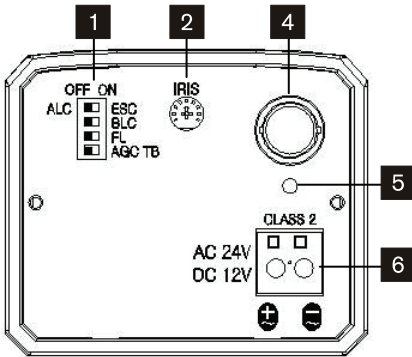

VTC-C750/DN

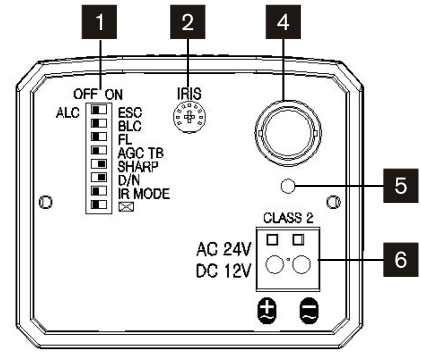

1) Function Switches (SW1 ~4/8)

2) Iris Level Control

3) Lens Select Switch

4) Video Output Connector

5) Power Indicator LED

6) Power Input Terminal (Terminal Block)

EXTERNAL CONTROLS

Potentiometer for Iris level control:

Used to set the video level by adjusting the iris of the connected DC drive (or Video) auto iris lens. This excellent lens control characteristic makes it very precise, very stable, and very easy to adjust the video level.

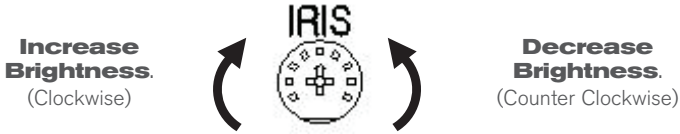

VTC-C680 & VTC-C750 Dip Switches:

	Function	ON	OFF
1	ALC / ESC	ESC	ALC
2	Back Light Control (BLC)	On	Off
3	Flickerless	On	Off
4	Auto Gain Control (AGC)	Turbo	Normal

* Factory Defaults Shown in Bold.

VTC-C680DN & VTC-C750DN Dip Switches:

	Function	ON	OFF
1	ALC / ESC	ESC	ALC
2	Back Light Control (BLC)	On	Off
3	Flickerless	On	Off
4	Auto Gain Control (AGC)	Turbo	Normal
5	Sharpness	ON	Off
6	Day / Night	ON	Off
7	IR Mode	On	Off
8	N/A		

* Factory Defaults Shown in Bold.

EXTERNAL CONTROLS

SW 1. ALC / ESC (Default: ALC)

Used to select iris control mode. When set to ESC, camera operates in electronic shutter control (ESC) mode and can be installed with a manual or fixed iris lens. ESC mode is the most economic solution but may have some following disadvantages comparative to ALC mode with auto iris lens:

- More smear and less clear image when shooting the very bright object.
- Color rolling or video level hunting may occur under the florescent light when the camera operates in ESC and INT modes (NTSC version only).

When set to ALC, camera operates in auto iris lens control mode and should be installed with an auto iris lens. Auto iris lens is used for best quality video.

SW 2. BLC (Backlight compensation) ON/OFF (Default: OFF)

If the subject you wish to view is too dim because of a bright background, set the BLC switch to ON to compensate for the bright background. With BLC on, the background brightness may saturate in some cases. This function may not operate properly if the object is too small compared to the area of the background. This function can be used with the linear shutter (EE or ESC) and be OFF with auto iris lens (AI lens or ALC mode).

SW 3. Flickerless ON/OFF (Default: ON)

Flickerless mode is useful in areas where AC main is 50Hz and TV system is NTSC such like Japan or AC is 60Hz and TV system is PAL to reduce the flicker under the florescent light. Where FL is set to ON, the low light sensitivity is down about 30%.

SW 4. AGC Turbo ON/ OFF (Default: OFF)

AGC is Automatic Gain Control

SW 5. Sharpness ON/OFF (Default: ON)

SW 6. Day-Night (ICR) ON/OFF (Default: ON)

DAY-NIGHT ON/OFF SW enables or disables the day-night mode. If set to ON, day-night mode is enabled and camera determines to enter / exit NIGHT mode from / to DAY mode automatically according to the scene illumination. When the scene illumination is getting darker than a half video level, camera changes its mode to NIGHT and removes its optical filter to get a higher video level and switches to B/W mode.

In NIGHT mode, camera provides the real time B/W video and can accept the IR light. When the illumination is getting brighter, camera returns to DAY mode and returns its optical filter and switches to Color mode.

If set to OFF, camera operates just like a normal camera and does not perform NIGHT mode.

EXTERNAL CONTROLS

SW 7 IR mode ON/OFF ((Default: OFF))

Used to reduce a possibility from Day to Night or reverse under a certain scene illumination. This mode was derived from a IR Cut filter mechanism which is switched from day to night or night to day based on scene illumination. A typical IR cut filter type D/N camera could be switched from color to B/W or reverse under specific scene illumination values, but sometimes iterations occur when switching from/to (Night <--> Day) under specific external IR light source. VITEK IR mode can give a little margin of the IR iteration at specific condition by increasing the threshold value (Night to Day) adjustment.

When IR mode is enabled, it reduces iteration of the filter switch (repeated IN and-OUT) during varying lighting conditions. In IR mode, the Night to Day threshold will be around 6.0Lux and around 4.0Lux when off. The Lux is affected by scene illumination, but has a limit to reduce IR iteration under stronger external IR light.

SW 8. N/A (Reserved for future usage)

POWER SUPPLY CONNECTIONS

VTC-C680 / C750 Cameras are dual voltage and can work with either 12VDC or 24VAC power. A polarity-matched connection for 12VDC supply is NOT required. Primary and secondary grounds are completely isolated to reduce the possibility of ground-loop problems. An operating voltage range of 9.5V-30V for DC and 12-28.8V for AC provides extra installation flexibility.

Installation Notes:

Before applying voltage, first connect the power supply to the camera, then connect the power supply to an AC source. Connecting a live power supply directly to the camera could trigger an improper reset from power jitter and cause damage from surge voltage when there is no load.

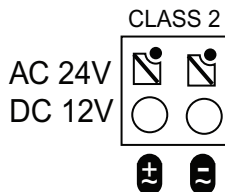

VTC-C680 / C750 SPECIFICATIONS

	VTC-C680	VTC-C750
Image Device	1/3" Sony New Structure Super HAD Color CCD	
Image Processor	DSP (Digital Signal Processor)	
Effective Pixels	768(H) x 494(V)	
Scan System	2:1 Interlace	
Scan freq.	60Hz(V), 15.75Khz(H)	
Sync. System	Internal	
Resolution	480TVL	550TVL
Sensitivity	0.2Lux (F1.2@40IRE)	
S/N Ratio	50dB (AGC OFF at 50IRE)	48dB (AGC OFF at 50IRE)
Electronic Iris	1/60 ~ 1/100,000sec	
White Balance	2000~8000°K Automatic tracking	
External Dip Switches	ALC/ESC, BLC, Flickerless, AGC	
External Potentiometer	Video Level Adjustment (Iris)	
Video Output	Composite: 1.0 Vp-p / 75 Ohm	
Lens mount	CS Mount	
Operating Power	12VDC/24VAC (Dual Voltage)	
Power Consumption	3 Watts (max)	
Operation Temperature	-10°C ~ +50°C, 85% RH. Max	
Dimensions (W x H x L)	2.56" x 2.17" x 4.17" (65mm x 55mm x 106mm)	
Weight	5.29 Oz. (150g)	

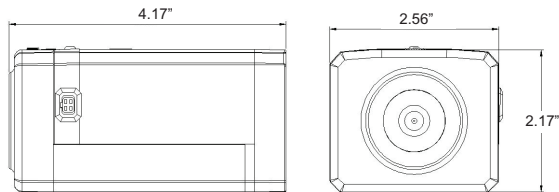

VTC-C680DN / C750DN SPECIFICATIONS

	VTC-C680DN	VTC-C750DN
Image Device	1/3" Sony New Structure Super HAD Color CCD	
Image Processor	DSP (Digital Signal Processor)	
Effective Pixels	768(H) x 494(V)	
Scan System	2:1 Interlace	
Scan freq.	60Hz(V), 15.75Khz(H)	
Sync. System	Internal	
Resolution	480TVL	550TVL
Sensitivity	0.02Lux (F1.2@40IRE)	
S/N Ratio	50dB (AGC OFF at 50IRE)	48dB (AGC OFF at 50IRE)
Electronic Iris	1/60 ~ 1/100,000sec	
White Balance	2000~8000°K Automatic tracking	
External Dip Switches	ALC/ESC, BLC, Flickerless, AGC, Sharpness, Day/Night, IR Mode	
External Potentiometer	Video Level Adjustment (Iris)	
Video Output	Composite: 1.0 Vp-p / 75 Ohm	
Lens mount	CS Mount	
Operating Power	12VDC/24VAC (Dual Voltage)	
Power Consumption	3 Watts (max)	
Operation Temperature	-10°C ~ +50°C, 85% RH. Max	
Dimensions (W x H x L)	2.56" x 2.17" x 4.17" (65mm x 55mm x 106mm)	
Weight	5.29 Oz. (150g)	

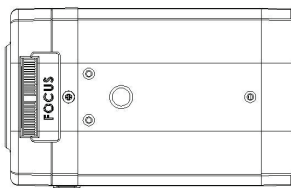

LIMITED LIABILITY WARRANTY

Your new Camera is guaranteed to be free from defects in materials and workmanship for a period of three years from the date of purchase.

The product must have been used only for its intended purpose, and not been subjected to damage by misuse, willful or accidental damage, caused by excessive voltage or lightning.

The product must not have been tampered with in any way then the guarantee will be considered null and void.

This guarantee does not affect your statutory rights.

Contact VITEK or your local distributor if servicing should become necessary.



28492 CONSTELLATION ROAD VALENCIA, CA 91355
WWW.VITEKCCTV.COM | 888-VITEK-70